



BRUAG
Innovation for Architecture

Ventilated Facade

CELLON[®] classic, stripes

Technical data sheet for planning,
construction and execution

A.1

Version 3.0

Table of Contents

General Information

01.

- Material P.1
- Panel Formats P.1
- Data Transmission for Orders P.2
- Storage and Cleaning Instructions P.2
- Cutting and Drilling Guidelines P.2

Fastenings

02.

- Fastening Distances P.3
- Fasteners P.4
- Concealed Mounting with Gluing Systems P.5-6

Substructure

03.

- Wooden Substructure P.7
- Metal Substructure P.8

Corner & Transition Profiles

04.

- Corner Constructions P.9
- Corner Profiles P.9

Construction Solutions

05.

- Facade Constructions P.10-12
- Window Details P.13-14
- Base Details P.15
- Flat Roof Connections P.15
- Pitched Roof Connections P.15

Design-Ideas

06.

- our catalogue P.16

General Information

01.

Material

Our **CELLON® panel** is a high-pressure laminate panel (HPL Compact or solid core panel) consisting of 70% cellulose webs and 30% phenolic resin. The extremely weather and frost-resistant material is ideal for outdoor applications.

- Application area:** mounted vertically in outdoor areas (e.g. facades, balcony railings)
- Panel thickness (weight):** 8mm (approx. 12kg/m²), 10mm (approx. 15kg/m²)
- Reaction to fire class:** RF2, B1 (DIN 4102-1), B-s1-d0 (EN 13501-1)

The raw panels are project-specifically cut to the desired dimensions using laser technology (including drill holes). You choose the **width (x)** and the **length (y)** of the panels individually. Do you want round cuts or additional cut-outs? Simply draw them in your DXF plan and they will be **manufactured to size**.

Panel Formats

Please consider the following raw panel formats for waste optimisation:

large-format panels

CELLON® classic

Raw width	Raw length
1200 mm	2400 mm
1280 mm	3000 mm *
900 mm	3600 mm

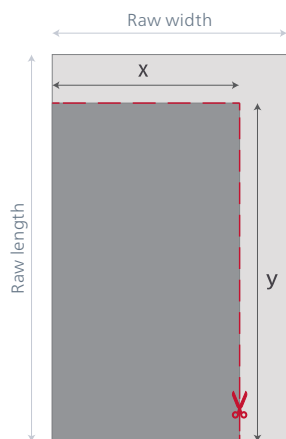

small-format panels

CELLON® stripes

Length	Width
1195 mm	145 mm
1795 mm	145 mm



Note

Whenever possible, the raw material sizes should be considered when planning the panel layout so that panel waste can be minimised. We support you with this.

*Only this format is also available with a decor surface in stone or wood look.

General Information

01.

Data Transmission for Orders

Please note the following when placing an order:

Data Format

- DWG / DXF Data
- Cadwork 2D or 3D Data
- Parts lists in Excel (if only as Excel without CAD file is sent, it might result in additional work in our work preparation)

Data Content and Structure

- Panels are drawn on a separate layer
- Drawing in 1:1 ratio
- Measurement of at least one long and short side to be able to verify the scale
- Boreholes (drawn as a closed circle), cut-outs, etc. are marked accordingly
- Special requests for grouping and/or palletisation must be explicitly specified. Normally there is room on one pallet for 120 square metres of panels. Within the pallet there is no sorting by panel numbers etc.

Own Design (the following specifications must be observed for own designs)

- Design must be created as CAD drawing (DWG or DXF file)
- Contours must be neatly closed and drawn as a line (not several lines on top of each other)
- Size ratio must be clearly visible

In the event of post-processing by Bruag Design Factory AG, the resulting additional work will be invoiced.

Storage and Cleaning Instructions

CELLON® panels must never be stored unprotected horizontally outdoors. If water remains on the horizontally lying panels, damage to the paint may occur! Please always place the dry PU foam foils supplied as a separating layer between the individual boards.

The boards can be cleaned with water and a cloth or magic sponge. Careful use of a high-pressure cleaner is also possible with sufficient distance and little pressure. Do not use any chemical cleaning agents.

Cutting and Drilling Guidelines

Basically, cutting to size on site should be avoided and the panels should already be ordered to the project-specific size whenever possible. However, in exceptional cases it is possible to process the panels on site, with the note that the panels are coated and the cut edge will therefore not have the same colour after cutting as the surface. Tools with carbide cutting edges or diamond cutting edges are advantageous as cutting items. The visible side should be at the top when cutting and, if possible, a guide rail should be used.

Spiral or dowel drills made of solid carbide are ideally used for drilling.

The material does not require post-treatment from the point of view of weather protection. However, if necessary, the edge can be coated with the supplied reserve paint.

Fastenings

02.

Fastening Distances

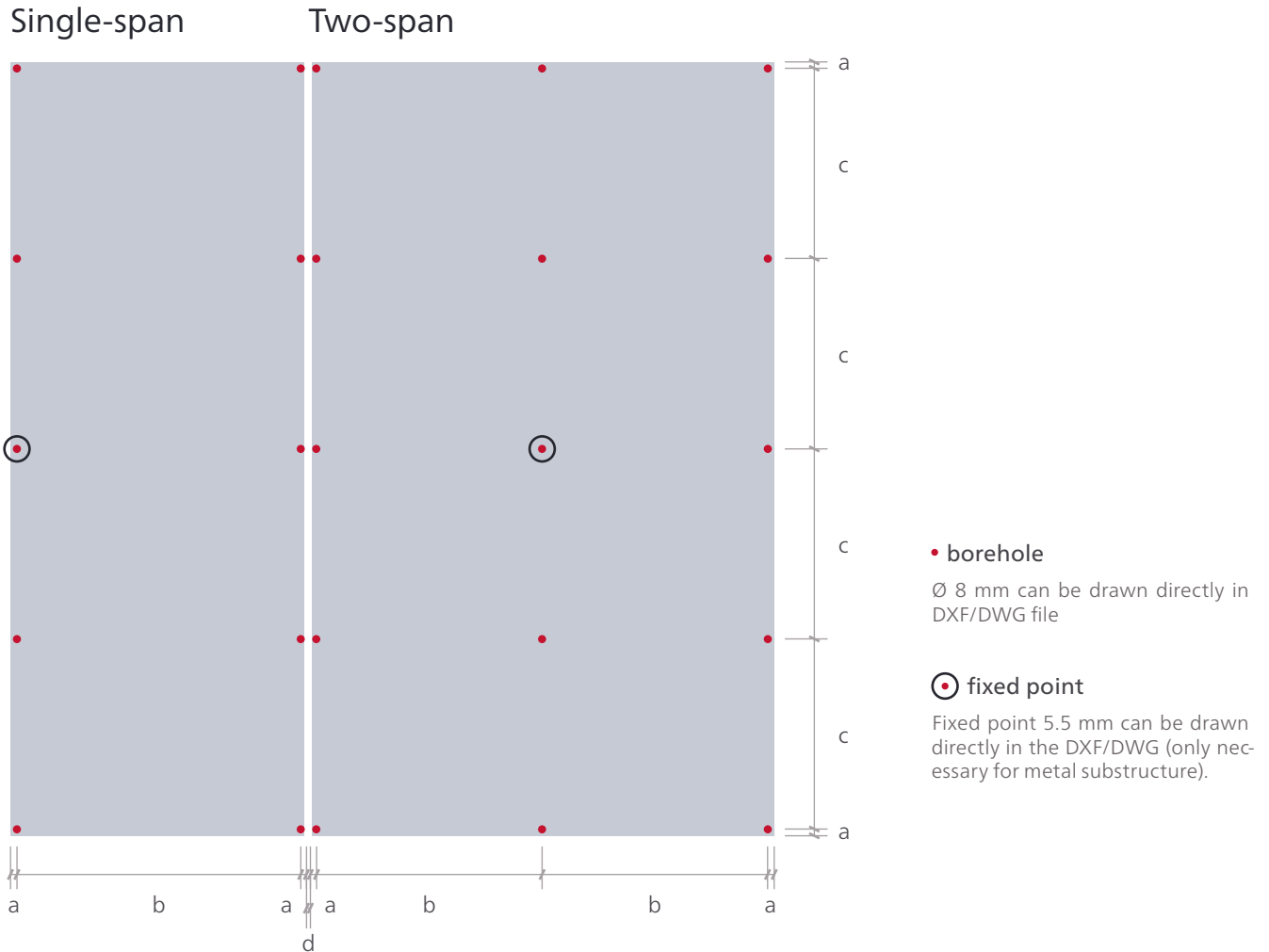

Stripes

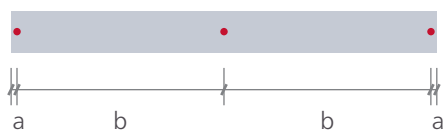

Maximum distance according to wind load q_{ek} (wind pressure or suction)

Position in mm	Description	CELLON® 8mm				CELLON® 10mm			
		0.5 kN/m ²	1.0 kN/m ²	1.5 kN/m ²	2.0 kN/m ²	0.5 kN/m ²	1.0 kN/m ²	1.5 kN/m ²	2.0 kN/m ²
a	Distance borehole to edge	20				20			
b	Horizontal borehole distance	970	815	735	685	1300	1200	1030	890
c	Vertical borehole distance	645	465	350	235	290	170	130	115
d	Joint	6				6			

Reciprocal conversion:

$$c \text{ (adjusted)} = b \text{ (max)} / b \text{ (effectiv)} \times c \text{ (max)}$$

$$b \text{ (adjusted)} = c \text{ (max)} / c \text{ (effectiv)} \times b \text{ (max)}$$

The values given are guidelines and do not release you from having an object-related inspection carried out by a qualified engineer. Test results for the tests according to EN 789, EN1048, EN 14358, EN 383, EN 1383, EN 310 and EN 13879 can be found in a separate test report.

Fastenings

02.

Fasteners

Wooden Substructure

Truss-head Screw

Material:	Stainless steel A2
Length:	38 mm
Nominal diameter:	4.8 mm
Head diameter:	12 mm
Drives:	TX20
Borehole diameter:	8 mm



Metal Substructure

Hexagon-head screw (self-drilling with sealing washer)

Material:	Stainless steel A2 (with drill point and shaped thread made of hardened steel)
Length:	32 mm
Nominal diameter:	5.5 mm
Head diameter:	16 mm
Drives:	SW8, hexagon head
Borehole diameter:	8 mm



Blind Rivet

Material:	Aluminium/Stainless steel A2
Length:	8-13 mm
Nominal diameter:	5.0 mm
Head diameter:	14 mm
Drives:	Blind rivet tool
Borehole diameter:	8 mm



Note

Screws and rivets are to be placed concentrically in the drilled holes.
NO COUNTERSUNK SCREWS MUST BE USED!

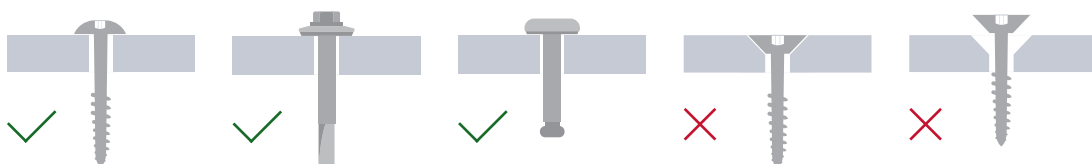

Fastenings

02.

Concealed Mounting with Gluing Systems

An alternative to mechanical attachment with screws or rivets is to glue the CELLON® panel with a suitable adhesive system. The adhesive system must be permanently flexible and come from a qualified adhesive system manufacturer approved for the mounting of Facade panels.

Depending on the approval of the adhesive system manufacturer, CELLON® panels can be used on both wooden and metal substructures. The local regulations and test standards for adhesive installation, project-related approval by the adhesive system manufacturer and/or engineer, and ensuring professional installation must be observed in all case. The following installation instructions are to be understood as a planning aid and do not replace the project-specific approval by the authorities, the engineer and the adhesive system manufacturer. The processing instructions of the individual adhesive system manufacturers are binding. Among other things, the following points should be observed during adhesive installation:

Surface Pre-treatment (Substructure and CELLON® panel)

- All adhesion surfaces must be clean, dry, free from grease, oil and dust
- Clean and, if necessary, sand and prime according to the specifications of the adhesive system manufacturer
- Ventilation times according to the system manufacturer must be observed

Processing

- Processing instructions such as temperature and humidity specifications must be applied and monitored
- Adhesive and adhesive tapes must be applied correctly and procedures for removing protective films and skin formation times must be observed
- Minimum lengths of adhesive surfaces according to the manufacturer’s requirements must be fulfilled for all mounting points
- CELLON® sheet must be pressed evenly and firmly onto the adhesive surfaces. The correct adhesive layer thickness must be maintained

Fixing Distances*

Single-span

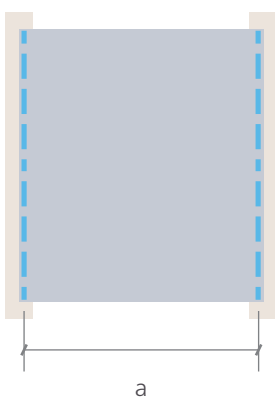

Two-span

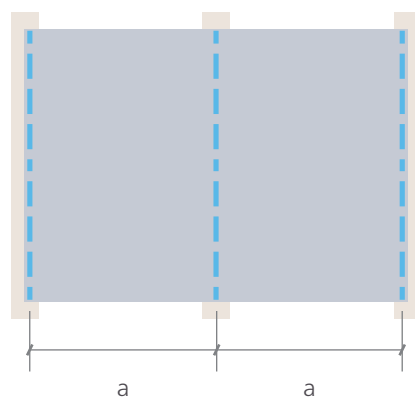

Stripes

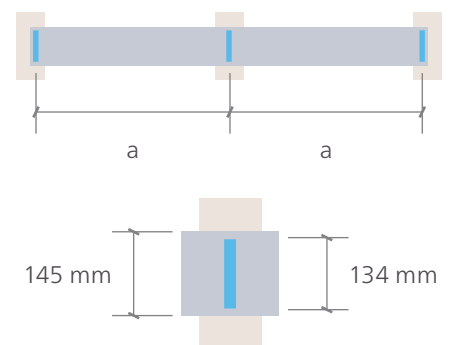

Position	Description	Minimum distance	Maximum distance	Recommended distance	Unit
a	Glue bead spacing	n/a	600	600	mm

* The fixing distances must be approved by the adhesive manufacturer depending on the wind load.

Fastenings

Adhesive System with Tape

e.g. Innotect Adhesal Project, DOWSIL™ 896 PanelFix, SikaTack® Panel
(test reports available separately)

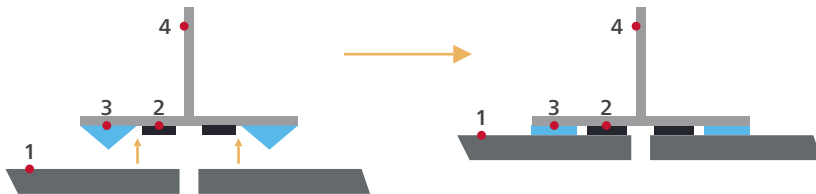

- 1 CELLON® panel
- 2 Double-sided tape
- 3 Adhesive
- 4 Metal substructure

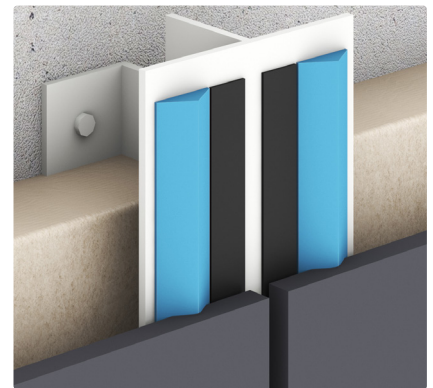

Adhesive System with Instant Adhesion

e.g. Bruag Easy-Fix on Metal Substructure

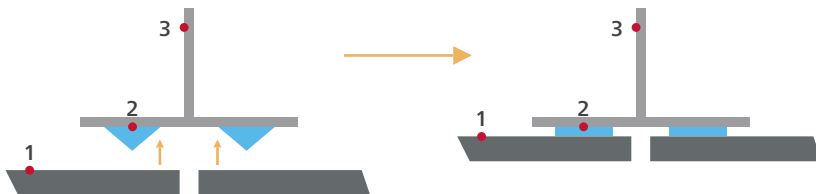

- 1 CELLON® panel
- 2 Adhesive
- 3 Metal substructure

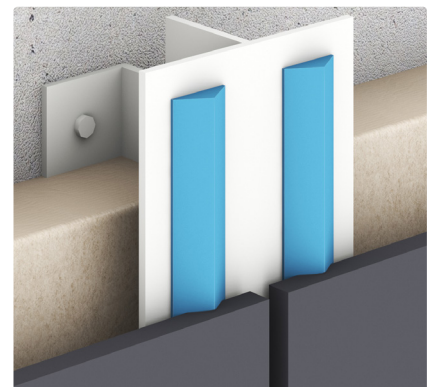

e.g. Bruag Easy-Fix on Wooden Substructure

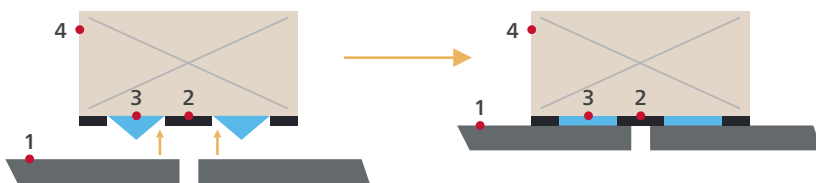

- 1 CELLON® panel
- 2 EPDM rubber backing strips*
- 3 Adhesive
- 4 Wooden substructure

* Special EPDM rubber backing strips for adhesive mounting on wooden substructure

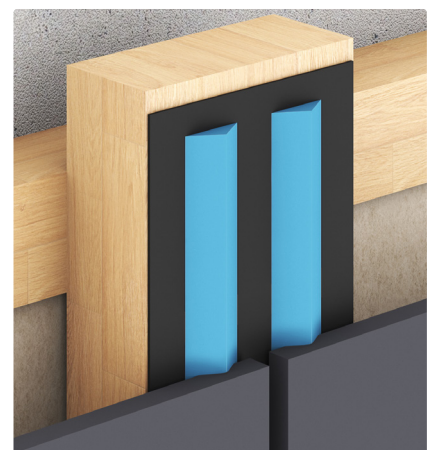

Substructure

03.

The substructure can be made of wood or metal. Material and load-bearing capacity must comply with the applicable standards. Compliance with the static and construction guidelines is the responsibility of the processor.

Wooden Substructure

Batten Width

in Joint Area

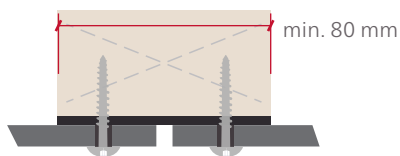

at Intermediate Batten

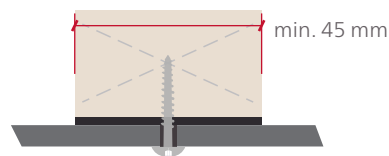

Batten Thickness

with Open Horizontal Joints

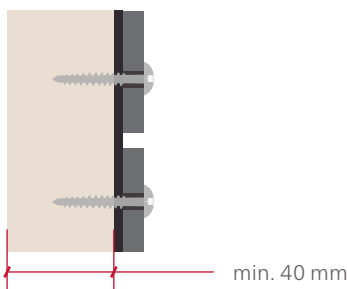

Horizontal joints can be left open. In this case, the ventilation space must be at least 40 mm. (cf. chapter 1.16.1 Technifo 4 of the SFHF).

with Closed Horizontal Joints

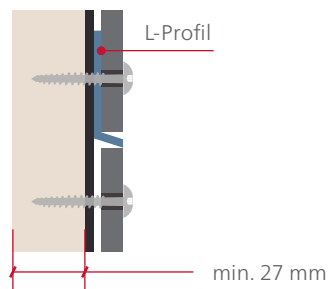

Horizontal joints can be closed with L or Z profiles, for example. Common aluminum or plastic profiles can be used.

Construction Specifications

Effective protection against moisture is essential to ensure the durability of a wooden substructure. The following design measures must be observed:

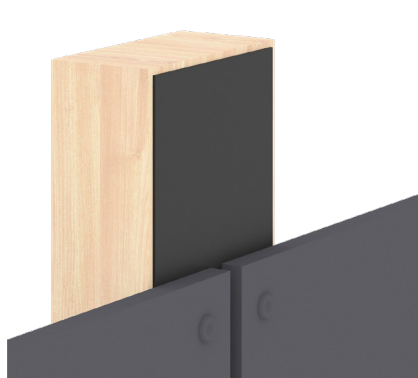

Protection against moisture

The battens are to be covered with an EPDM rubber backing strips that protects the slat over the entire width and height.



Protection against splashing water

Wooden battens must be at least 300 mm above the water-bearing layer. For smooth floors above the spray area.

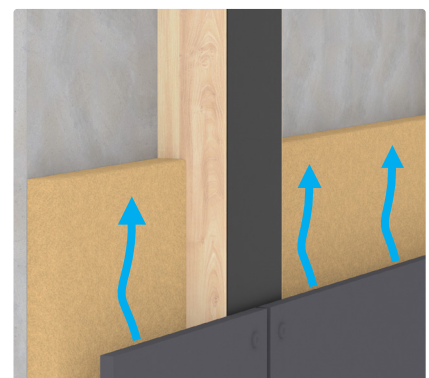

Protection against condensate

The ventilation space must have a permanent vertical flow. In the case of open joints, a ventilation space of at least 40 mm depth is required.

Substructure

03.

Metal Substructure

Profile Width

in Joint Area

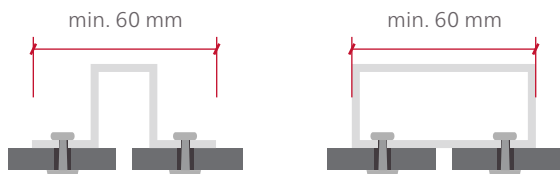

at Intermediate Profile

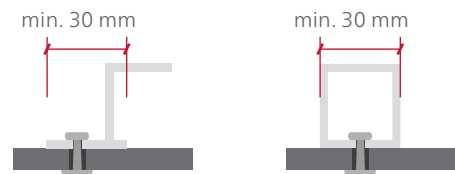

Profile Depth

with Open Horizontal Joints

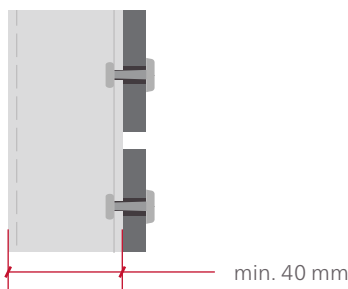

Horizontal joints can be left open. In this case, the ventilation space must be at least 40 mm. (cf. chapter 1.16.1 Techno 4 of the SFHF).

with Closed Horizontal Joints

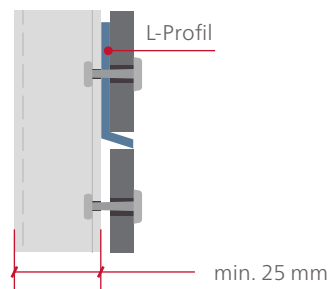

Horizontal joints can be closed with L or Z profiles, for example. Common aluminum or plastic profiles can be used.

Construction Specifications

In order to cope with the greater linear expansion of a metal substructure, the following design measures must be observed:

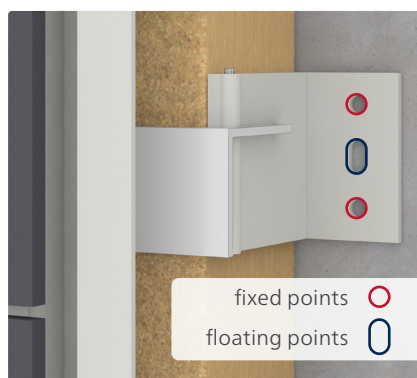

Protection against deformation

For vertical and horizontal profile connections, fixed and sliding points must be implemented according to the manufacturer's instructions.

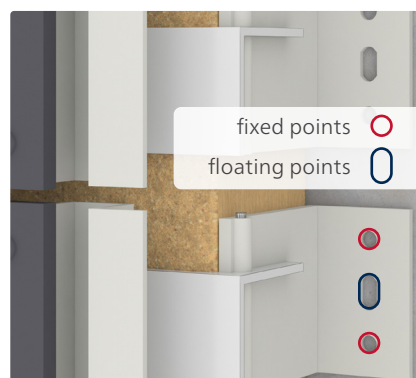

Protection against tension

Long profiles (>3000 mm) are to be separated by dilatation joints. Profile joints are to be formed in the panel joints.

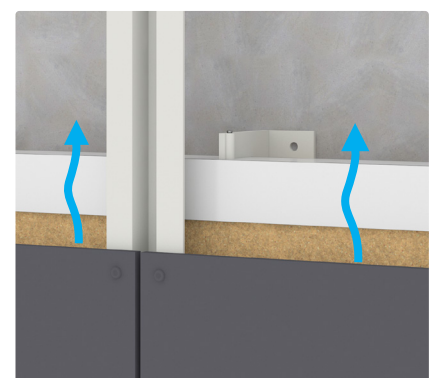

Protection against condensate

The ventilation space must have a permanent vertical flow. In the case of open joints, a ventilation space of at least 40 mm depth is required.

Corner & Transition Profiles

04.

Corner Constructions

Wood Substructure

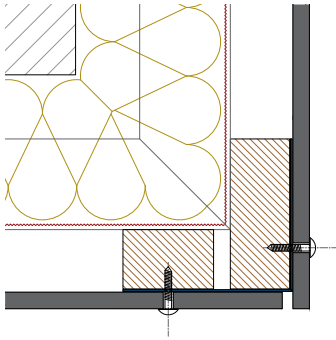

Metal Substructure

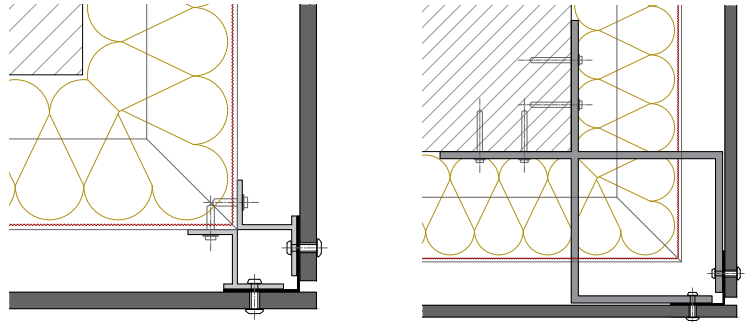

Corners can be formed butt-jointed or with standard corner profiles. The joint is to be planned with approx. 6 - 8 mm.

Corner Profiles

Butt-jointed

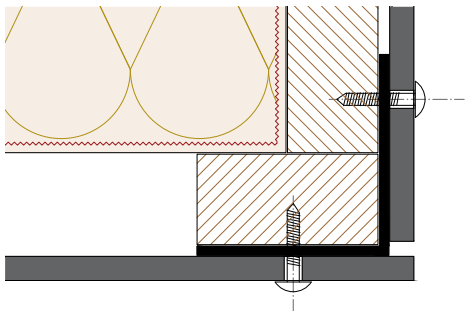

Cube Corner Profile

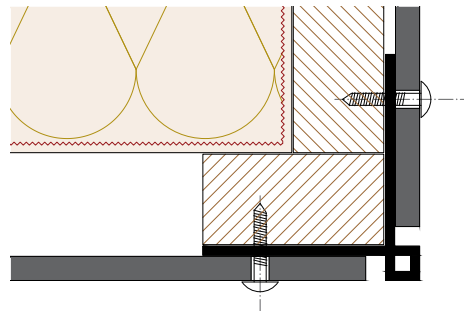

Cross Corner Profile

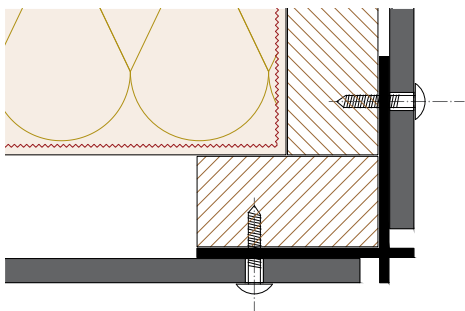

Cut Edge Cover Profile

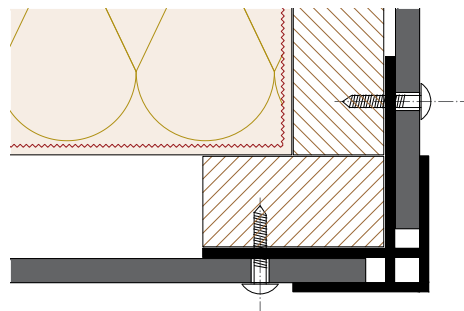

Butt-jointed

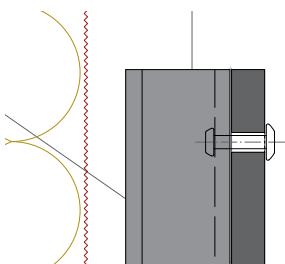

Rain Repellent Profile

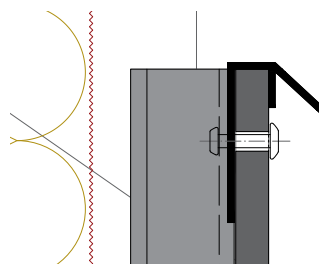

Construction Solutions

05.

Facade Constructions

Aluminum Console with Wooden Substructure

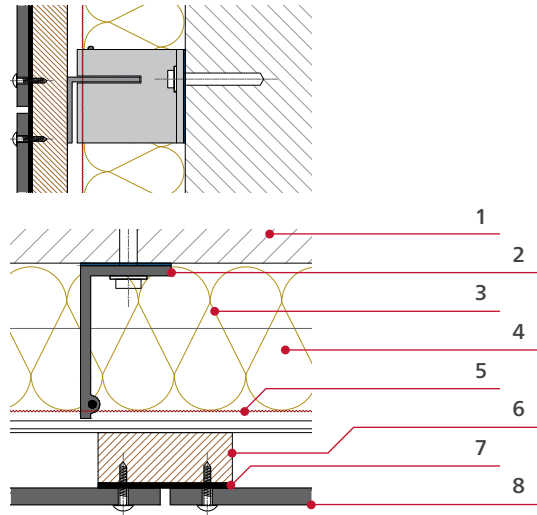
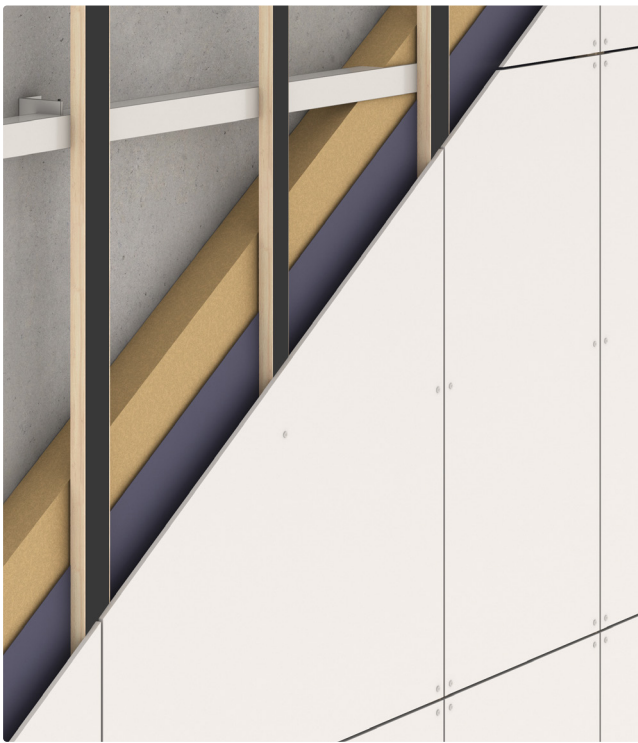

- 1 Wall
- 2 Aluminum bracket (without thermal bridges)
- 3 Insulation
- 4 Aluminium angle
- 5 Wind barrier
- 6 Batten
- 7 EPDM rubber backing strips
- 8 CELLON® panel

Aluminium Console with Metal Substructure

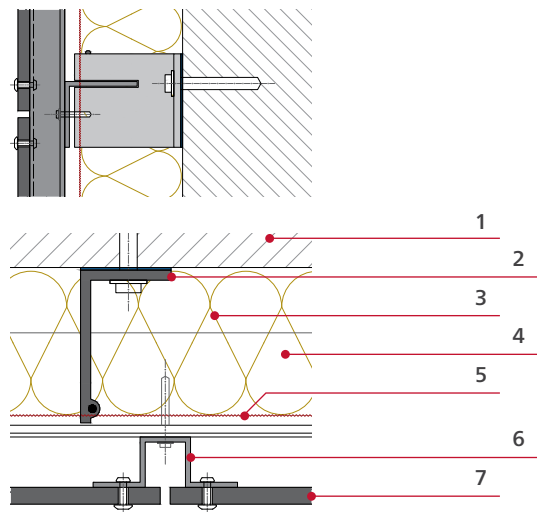
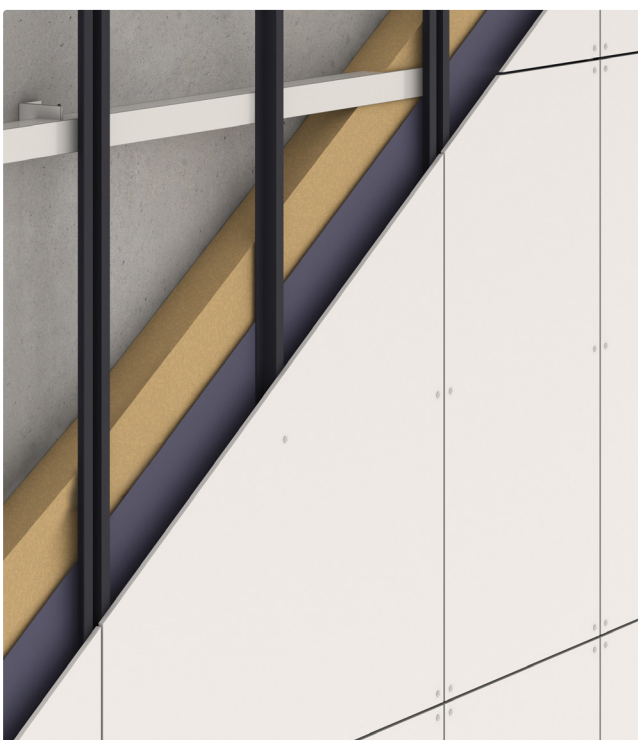

- 1 Wall
- 2 Aluminum bracket (without thermal bridges)
- 3 Insulation
- 4 Aluminium angle
- 5 Wind barrier
- 6 Metal profile (e.g. Omega-, Z-, square profile)
- 7 CELLON® panel

Construction Solutions

05.

Spacer Screws with Wooden Substructure

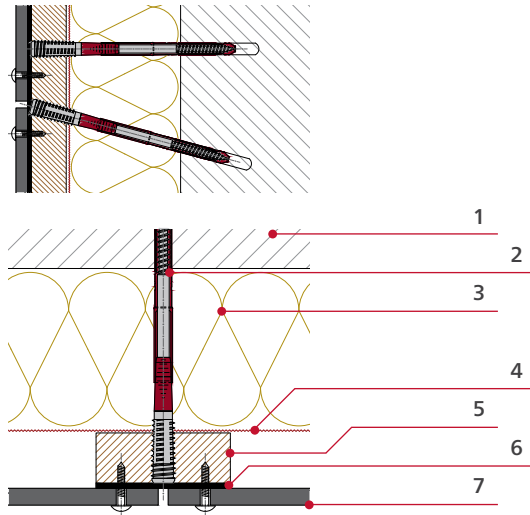
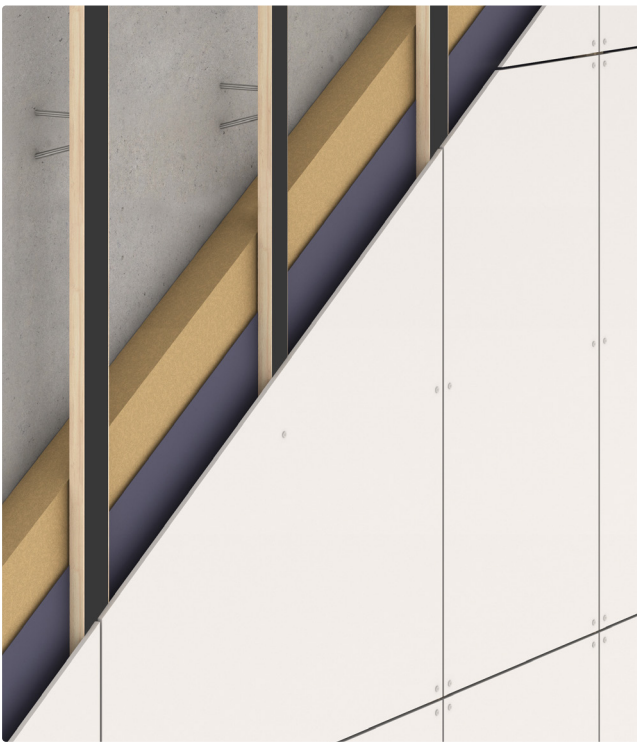

- 1 Wall
- 2 Spacer screw
- 3 Insulation
- 4 Wind barrier
- 5 Batten
- 6 EPDM rubber backing strips
- 7 CELLON® panel

Spacer Screws with Metal Substructure

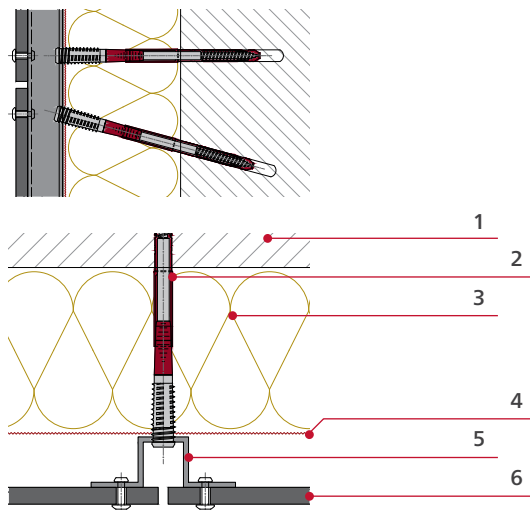
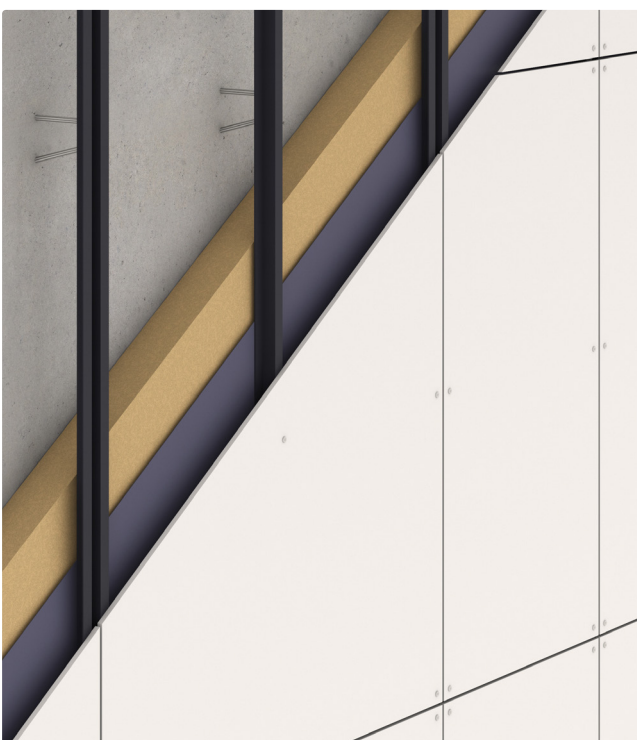

- 1 Wall
- 2 Spacer screw
- 3 Insulation
- 4 Wind barrier
- 5 Metal profile (e.g. Omega-, Z-, square profile)
- 6 CELLON® panel

Construction Solutions

05.

Cross Battens with Wooden Substructure

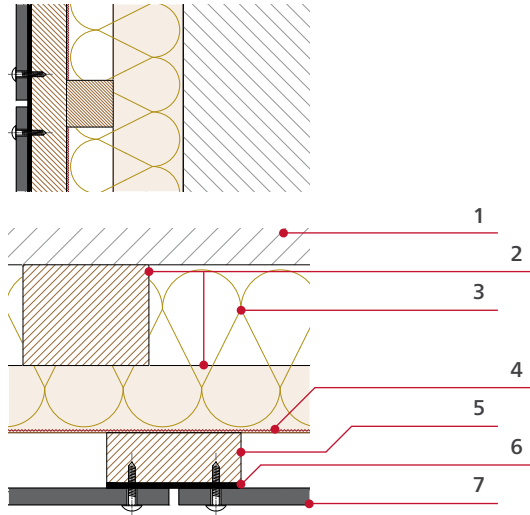
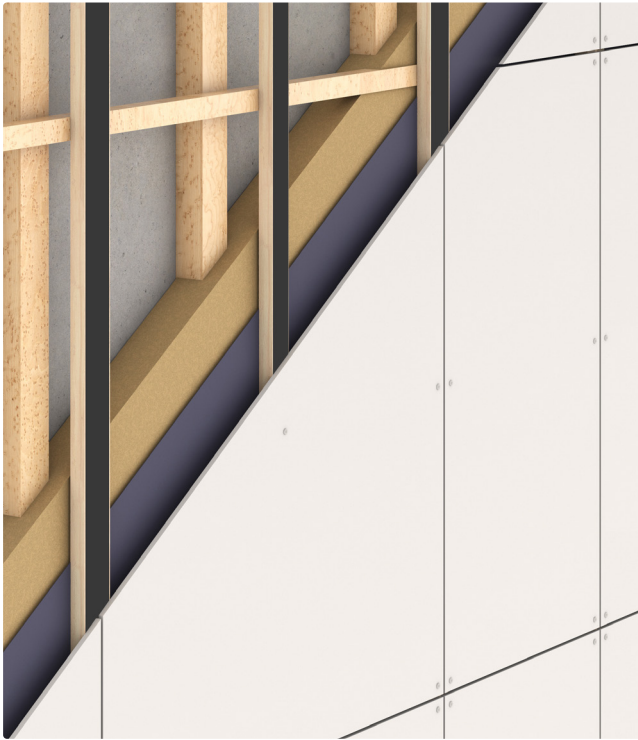

- 1 Wall
- 2 Cross battens
- 3 Insulation
- 4 Wind barrier
- 5 Batten
- 6 EPDM rubber backing strips
- 7 CELLON® panel

Refurbishment of External Wall Insulation with Wooden Substructure

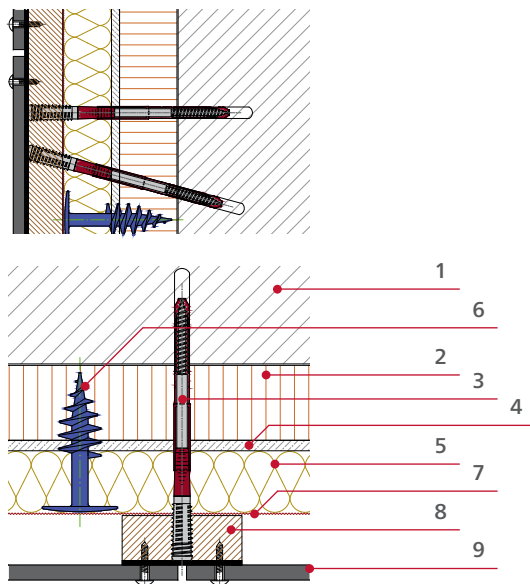
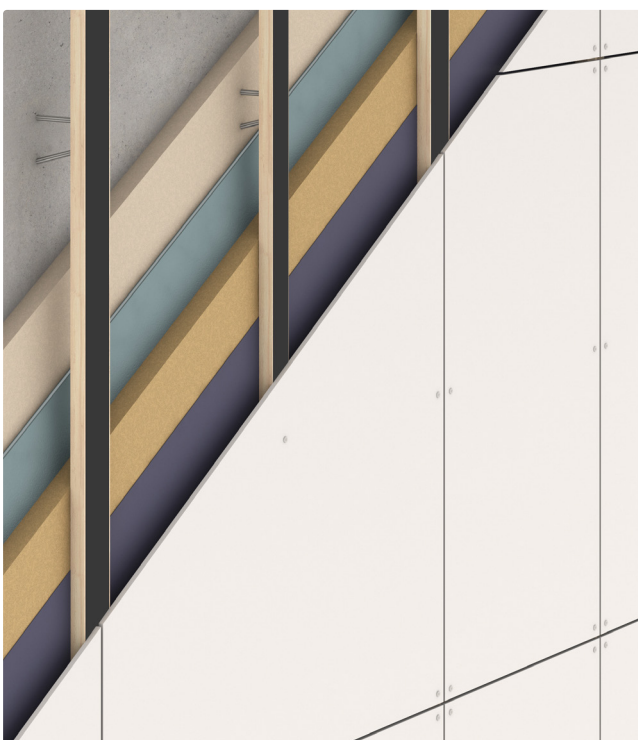

- 1 Wall
- 2 Insulation
- 3 Spacer screw
- 4 Plaster
- 5 Insulation
- 6 Insulation holder
- 7 Wind barrier
- 8 Batten
- 9 CELLON® panel

Construction Solutions

05.

The connection details listed below are exemplary. They can also be made with other wall constructions and other materials. The design of the connection and termination details is project-specific and must be developed by the implementation planner. Correct execution is the responsibility of the installer.

Window Details

Reveal Detail with Reveal Panel

Wooden Substructure

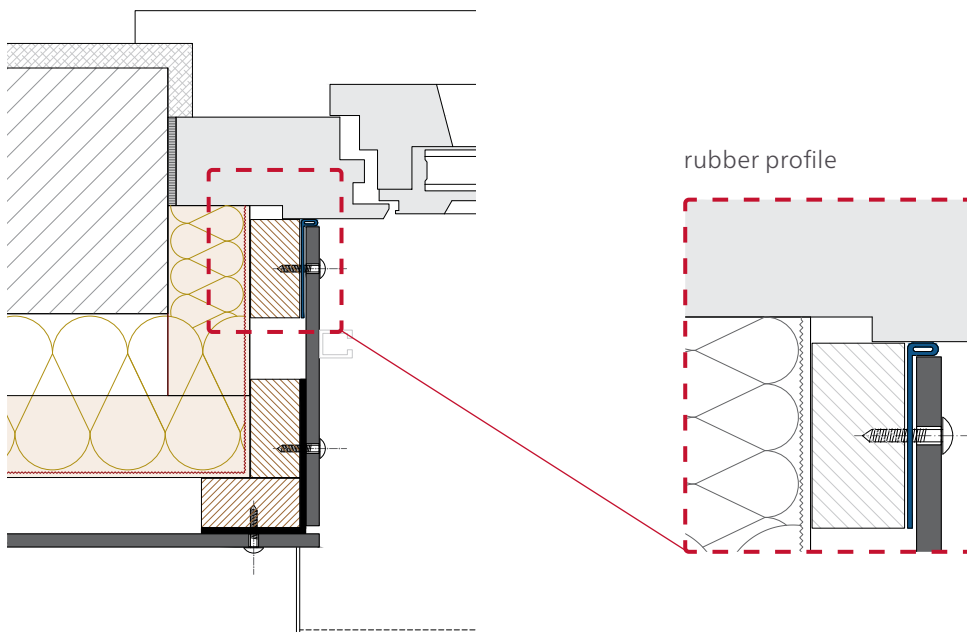

Metal Substructure

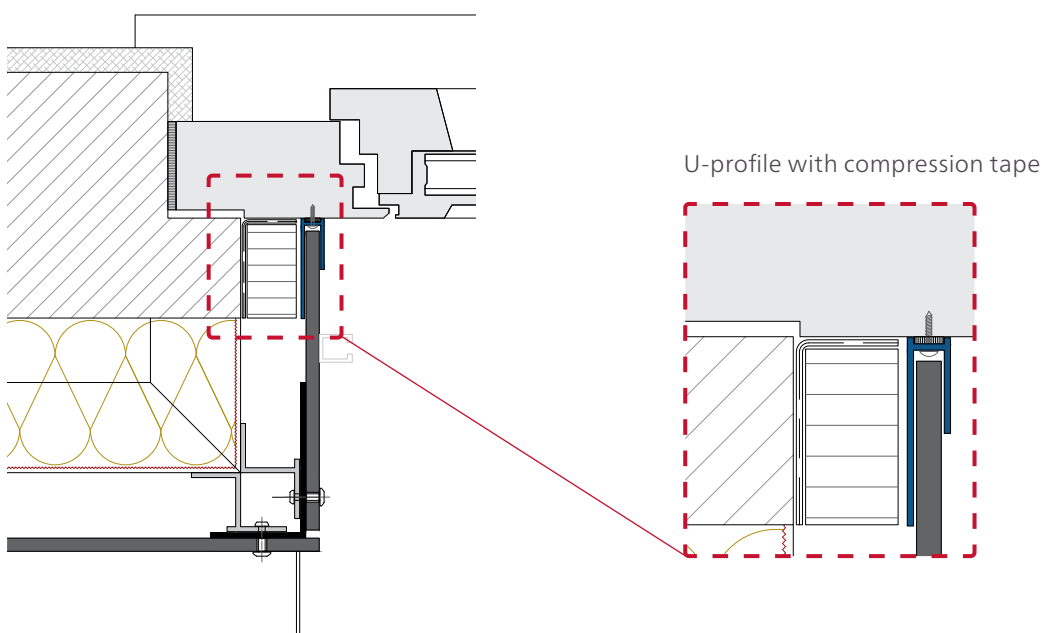

Construction Solutions

05.

Reveal Detail with Plug-in Window Frame

Wood Substructure

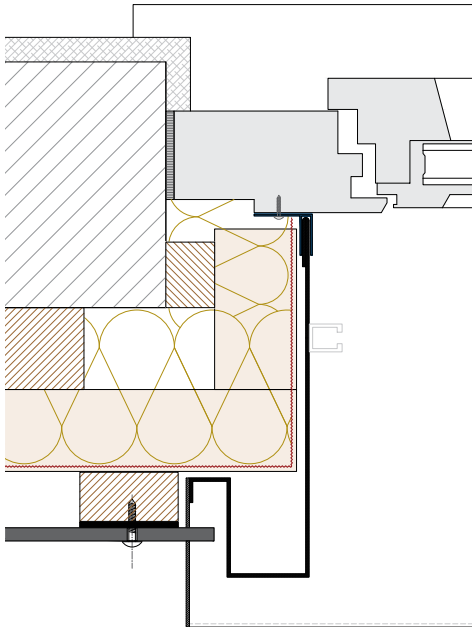

Metal Substructure

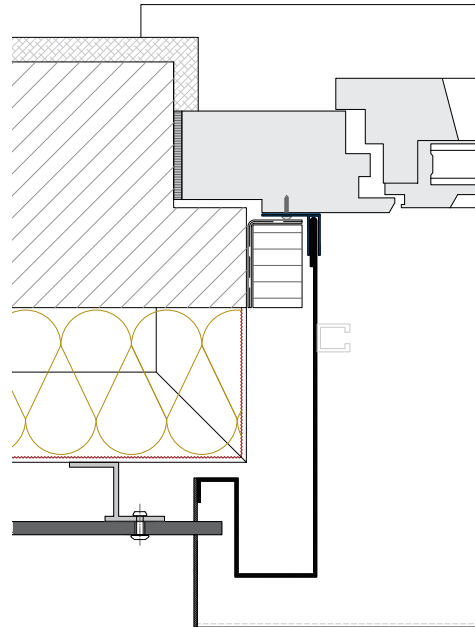

Window Sill & Lintel Detail

Wood Substructure

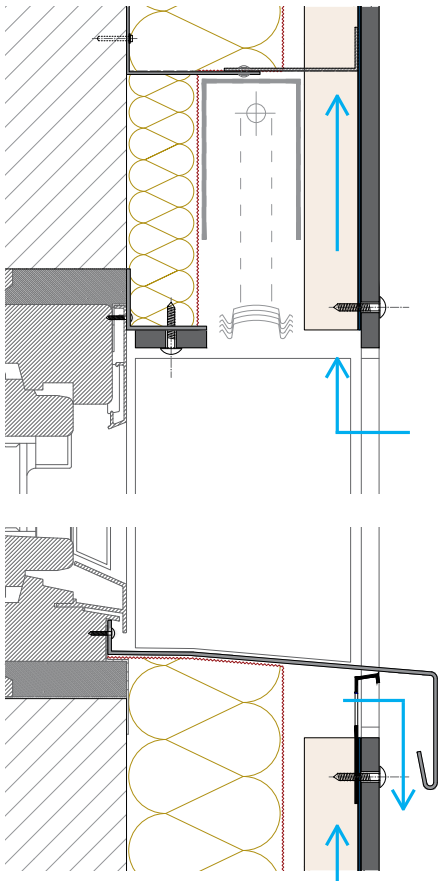

Metal Substructure

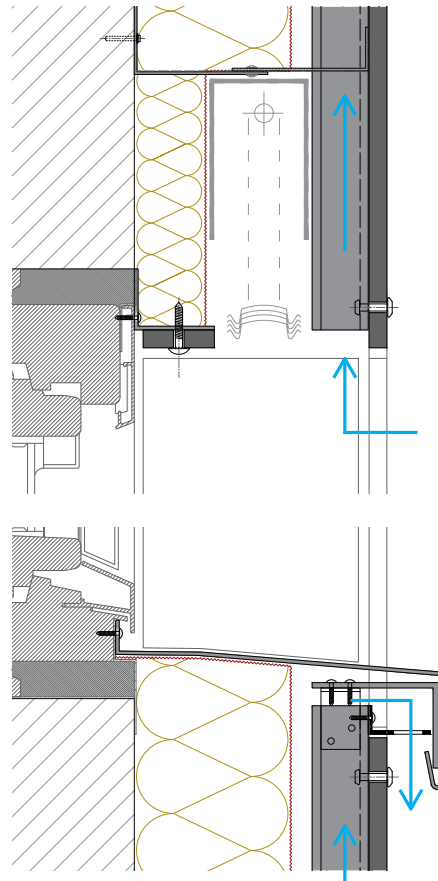

Construction Solutions

05.

Base Details

Wood Substructure

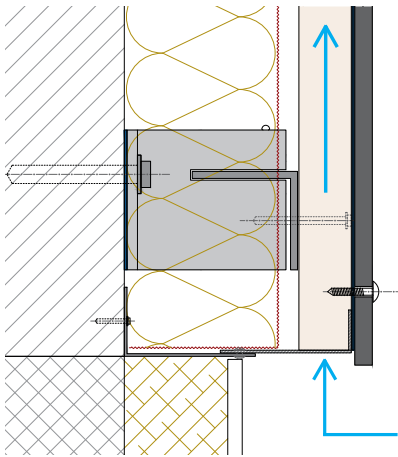

Metal Substructure

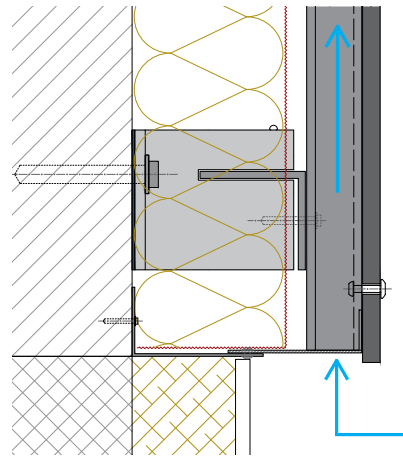

Flat Roof Connections

Wood Substructure

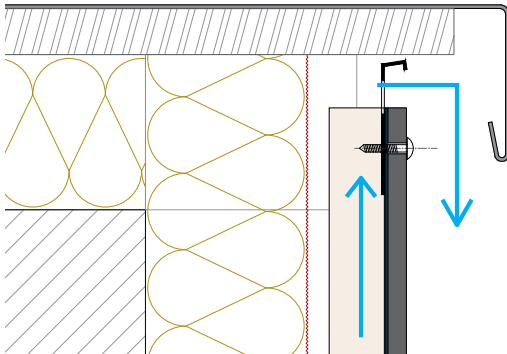

Metal Substructure

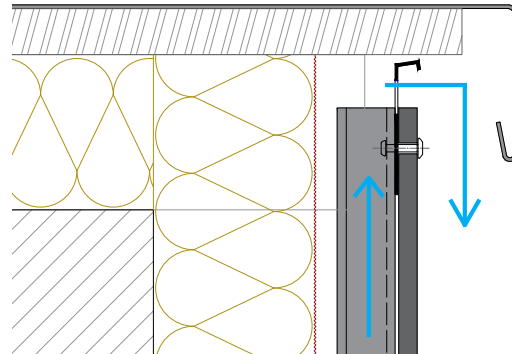

Pitched Roof Connections

Wood Substructure

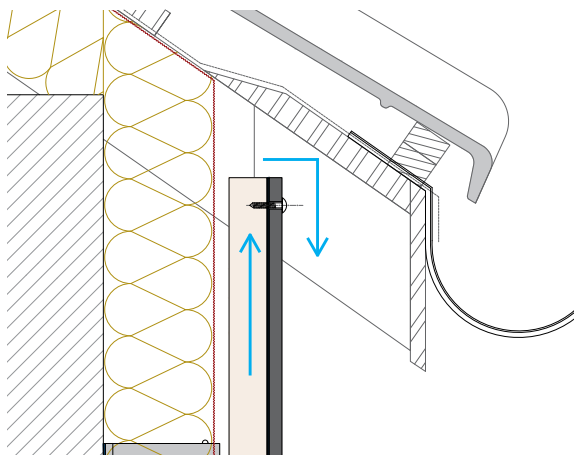

Metal Substructure

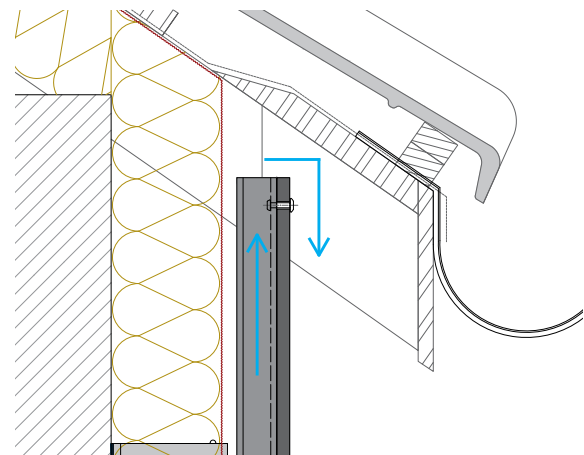

Design-Ideas

06.

All design ideas can be found in our catalogue.

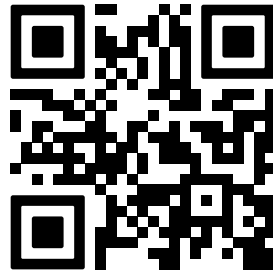

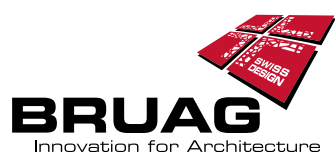

Bruag Design Factory AG
Switzerland

☎ +41 71 414 00 90

✉ info@bruag.ch

🌐 www.bruag.ch